

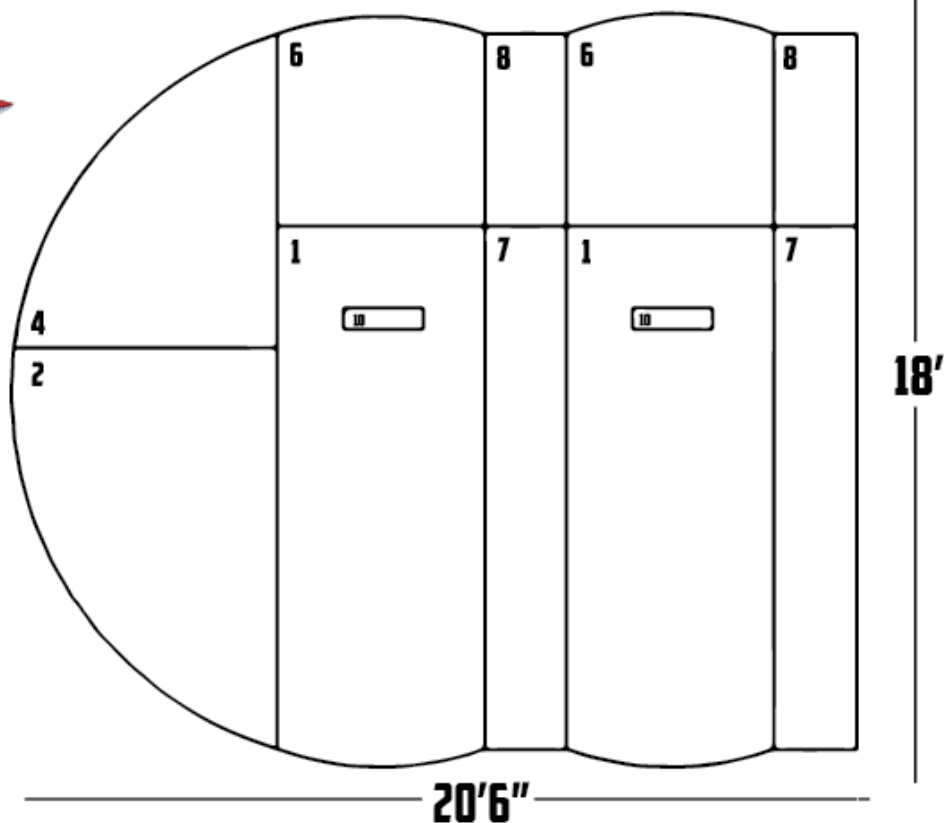









ON FIELD DOUBLE BULLPEN 1ST BASE



PRODUCT (#)	QTY.	WEIGHT	DIMENSIONS
 ADULT FRONT CENTER (1)	2	305 LBS.	156"Lx60"Wx10"H
 ADULT REAR CENTER (6)	2	125 LBS.	60"Lx60"Wx10"H
 ADULT FRONT SPACER (7)	2	120 LBS.	150"Lx24"Wx10"H
 ADULT REAR SPACER (8)	2	50 LBS.	58"Lx24"Wx10"H
 ADULT FRONT LEFT (3)	0	190 LBS.	116"Lx77"Wx10"H
 ADULT FRONT RIGHT (2)	1	190 LBS.	116"Lx77"Wx10"H
 ADULT REAR LEFT (5)	0	165 LBS.	91"Lx77"Wx10"H
 ADULT REAR RIGHT (4)	1	165 LBS.	91"Lx77"Wx10"H
 4 SIDED PITCHER'S RUBBER (10)	2	18 LBS.	24"Lx6"Wx6"H



FL416 SPORTURF SURFACE

- 1 3/4" pile height
- Polypropylene monophillment thatch
- Available in red clay w/red clay thatch, brown w/black thatch
- Infill product (sand/rubber)



INDUSTRIAL GRADE FIBERGLASS

- 10-limited warranty
- Patented "flange locking system"™
- Made in USA



3M LOW PROFILE HOOK & LOOP

- Polyester fastener with acrylic adhesive
- .3mm product thickness
- 1.1lb/in(sq) static shear strength
- Dynamic tensile: >0.69N/cm(sq)

PORTABLE. DURABLE. COMPATIBLE.



